

KZL strain relief plates

pluggable on 35 mm top hat DIN rails and C section rails C30



The strain relief plate KZL is used for static or dynamic applications for organising and securing cables on machines, control panels or drag chains.

The design of the strain relief unit provides secure strain relief according to EN 62444. Mount of the cables or pneumatic tubing is easily done using cable ties.

KZL Strain relief plates can be mounted on 35 mm top hat DIN rails and C section rails C30.



Specifications

Material	Polyamide
Flame class	UL94-V0, self-extinguishing
Operating temperature	-40 C° to 140 C°
Properties	silicone free, halogen free
Mounting options	Snap-in

Advantages & benefits

- Strain relief according to EN 62444
- Fast and easy mounting
- Cost-effective solution
- High cable density
- Versatile utilisation

Product types & sizes

KZL 11

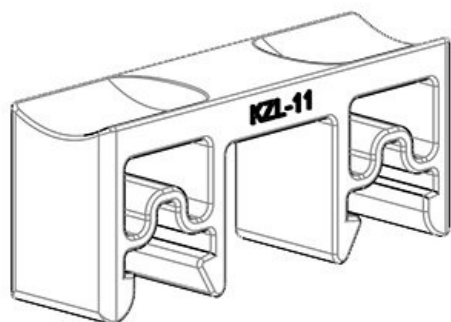

Part No.	32250	Mounting height	10,7 mm
EAN	4251269300	No. of teeth	1
Package quantity	10		
For max. no. of cables	1		
Length	11,5 mm		
Width	39,5 mm		
Height	16,5 mm		



Part No.	32260	Mounting height	10,7 mm
EAN	4251269300	No. of teeth	3
Package quantity	10		
For max. no. of cables	3		
Length	38,5 mm		
Width	39,5 mm		
Height	16,5 mm		

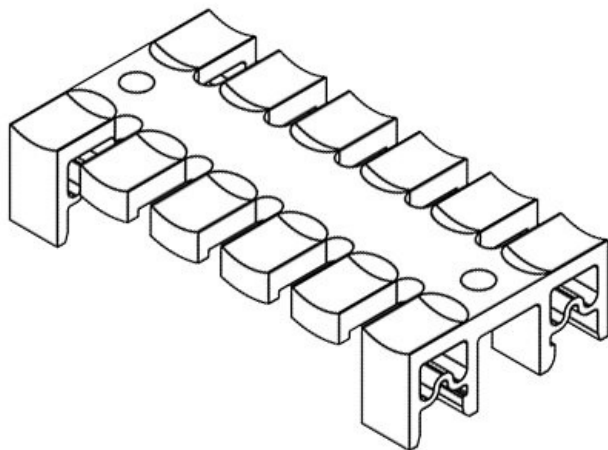

Part No.	32262	Mounting height	10,7 mm
EAN	4251269300	No. of teeth	6
Package quantity	10		
For max. no. of cables	6		
Length	79,5 mm		
Width	39,5 mm		
Height	16,5 mm		

Part No.	32264	Mounting	10,7 mm
EAN	4251269300	height	
	981	No. of teeth	9
Package	10		
quantity			
For max. no. of	9		
cables			
Length	139,5 mm		
Width	39,5 mm		
Height	16,5 mm		

